

FIREWALL INFORMATION

Attention Microsoft Windows XP and Windows 2003 Users!

Microsoft Windows Firewall:

Microsoft has included firewall protection on Windows XP with Service Pack 2 and on Windows 2003 Server with Service Pack 1. If you will be installing your timeQplus BIOMETRIC server on either of these two operating systems you will need to grant access on the firewall to the following applications and services after your installation is complete.

- Attendance Rx Note: You will be prompted to unblock this application after the installation is complete, or you can grant access via the firewall.
- arxsvc.exe
- ARXTQ100N.exe
- File and Printer Sharing

Other Firewalls:

Some firewalls block ports, and authorized applications can be granted access to use specific ports. If you have this type of firewall you should open the following ports:

- TCP Open ports 49183 to 49188
- UDP Open ports 49211 to 49212

NOTE: This equipment has been tested and found to comply with the limits for a Class B digital device, pursuant to Part 15 of the FCC Rules. These limits are designed to provide reasonable protection against harmful interference in a residential installation. This equipment generates, uses and can radiate radio frequency energy and, if not installed and used in accordance with the instructions, may cause harmful interference to radio communications. However, there is no guarantee that interference will not occur in a particular installation. If this equipment does cause harmful interference to radio or television reception, which can be determined by turning the equipment off and on, the user is encouraged to try to correct the interference by one or more of the following measures: Reorient or relocate the receiving antenna; Increase the separation between the equipment and receiver; Connect the equipment into an outlet on a circuit different from that to which the receiver is connected; Consult the dealer or an experienced radio/TV technician for help.

PN: 06-0349-000 Rev C.

timeQplus
BIOMETRIC

BIOMETRIC FINGERPRINT TECHNOLOGY



TQ100 Terminal User Manual

Product Reference Guide

Additional terminals, product upgrades and cables are available.
Please contact Acropoint at 1.800.334.7190 to order today.

Part Number: 01-0229-000

TQ100 terminal

Part Number: 01-0229-001

TQ100b - Terminal with operational back-up battery

Part Number: 08-0140-086

25 employee user upgrade

Part Number: 87-0106-000

FIU optical overlay

Part Number: 72-0203-000

485 cable for timeQplus Biometric (6 ft)

Part Number: 25-0134-000

485/232 Converter assembly (RJ11/9 PIN)

Chapter One: Introduction

1.1	Operating Environment.....	4
1.2	System Description	4
1.3	Enclosed Items	4

Chapter Two: Hardware Setup

2.1	Terminal Installation	5
2.2	Keyboard	5

Chapter Three: Menu Structure

3.1	Data Management.....	7
3.2	Setup.....	8
3.3	System Info	9

Chapter Four: Communications

4.1	Communication Interfaces	10
4.2	Communication Options.....	10
4.2.1	RS232 Serial Communication.....	11
4.2.2	RS485 Network Communication.....	12
4.2.3	Ethernet Communication.....	13

Chapter Five: Fingerprint Registration/Enrollment

5.1	Enrollment Method.....	14
5.2	Fingerprint Registration.....	16

Chapter Six: Terminal Usage and Punching In/Out

6.1	Successful validation when punching In/Out.....	20
6.2	Unsuccessful validation when punching In/Out..	21

Chapter Seven: Administrator Functions

7.1	Data Management.....	23
7.2	Setup.....	29
7.3	System Info	36

Chapter Eight: Appendix

8.1	RS232 Interface	37
8.2	RJ45 Interface.....	38

Chapter One: Introduction

Thank you for your recent purchase of the TQ100, a data collection terminal for timeQplus BIOMETRIC™ time and attendance system. This user manual provides specific information that will help you better understand the functionality of the terminal (TQ100). Some key areas that are important to the terminal's (TQ100) performance are the operating environment, the system overview, communication options and enrollment.

1.1 Operating Environment

Please read the manual carefully before using the product. The terminal operates most efficiently by following these recommendations:

1. DO NOT expose the TQ100 to direct sun light. Direct sunlight may impact the fingerprint reader optics and affect enrollment, quality of the templates, and performance of the fingerprint recognition process.
2. TQ100 operating temperature is 39F-110F. Do not operate the terminal outdoors. High temperature and humidity may affect its performance.

1.2 System Description

The timeQplus BIOMETRIC™ time and attendance system consists of two parts:

1. Fingerprint terminal TQ100
2. AttendanceRx, the time and attendance management software that runs on the PC.

The TQ100 terminal's main function is to register employees' fingerprints and record daily time and attendance. The PC software is used to manage the TQ100 and process employee information using a set of attendance rules defined by the Administrator. The PC software interacts with the terminal TQ100, calculates time, and generates reports. The time and attendance PC software application compatible with the TQ100 is called AttendanceRx.

Three communication options are available between the TQ100 terminal and the PC software: serial (RS232) and network (RS485, Ethernet).

1.3 Enclosed Items

1. Quick Start timeQplus BIOMETRIC installation guide
2. Time and attendance software CD, AttendanceRx
3. TQ100 biometric terminal
4. Hardware user manual for the TQ100
5. Serial RS232 cable, 30 feet (9 m)
6. CAT5 Ethernet cable, 6 feet (2 m)
7. Power adapter
8. Mounting plate and screws

Ethernet Communication Diagram

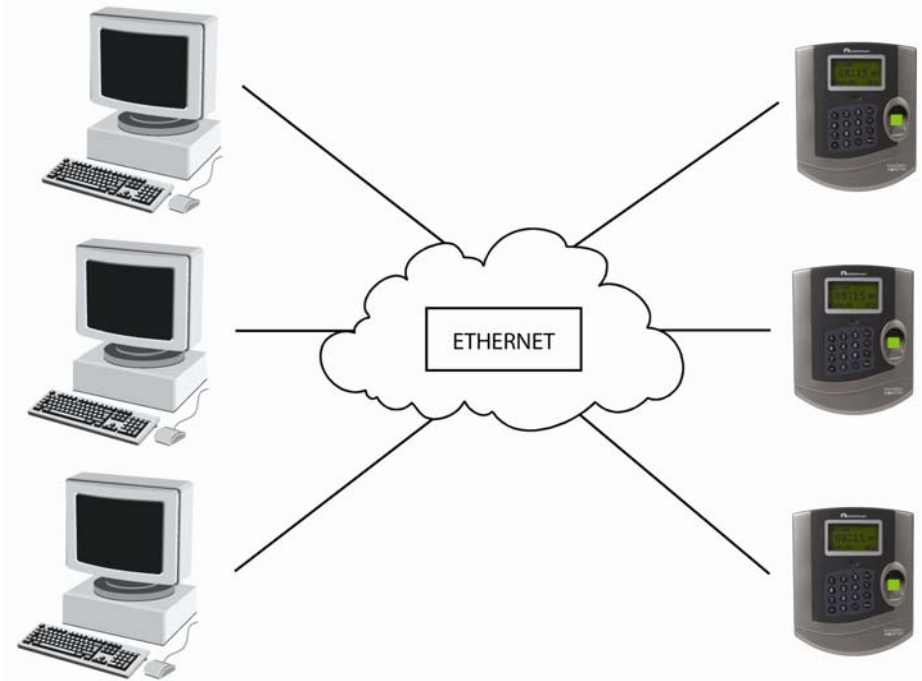

RS485 Wiring Diagram

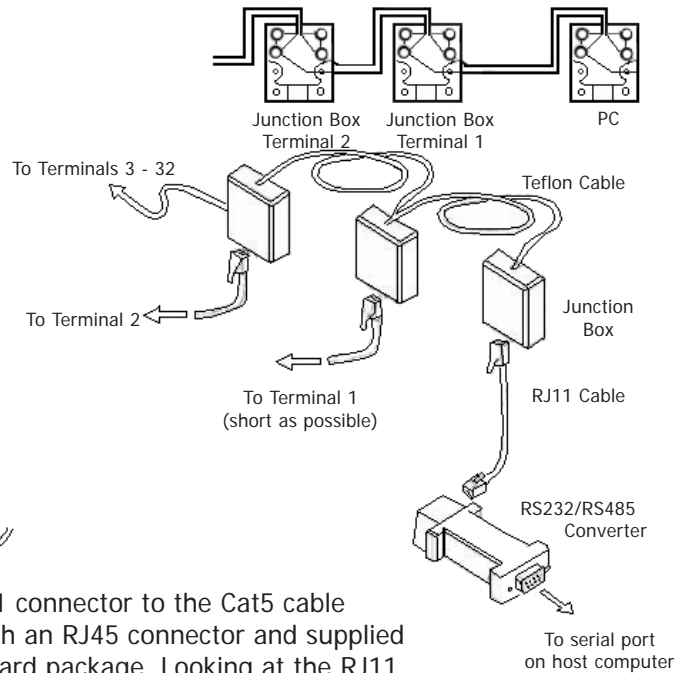

Attach an RJ11 connector to the Cat5 cable terminated with an RJ45 connector and supplied with the standard package. Looking at the RJ11 connector pictured above the Brown wire goes to the leftmost PIN and the Brown/White wire goes to the rightmost PIN.

Chapter Two: Hardware Setup

2.1 Terminal Installation

To power up the TQ100 biometric terminal:

- A) Unwrap the package and take out the terminal and accessories.
- B) Using the screws supplied, fasten the mounting plate on the wall in an appropriate place. Avoid areas with strong magnetic and/or electric fields.
- C) Attach the terminal to the mounting plate.
- D) Plug in the power supply and turn the terminal on (Press  button).

2.2 Keyboard image and functions

Keypad configuration is presented in Figure 2.1:

1	2	3	ESC
4	5	6	▲
7	8	9	▼
	0	OK	MENU

Figure 2.1

The keypad functionality is described below

- ESC** To perform EXIT, CANCEL, IGNORE when using the menu
- MENU** To access the Menu structure
- OK** To confirm and save the selection
-  Power switch
- ▲ Scroll-up button for menu operations
- ▼ Scroll-down button for menu operations
- 0 - 9** Keys to use when operating or performing system setup or entering User ID or password

Chapter Three: TQ100 Biometric Terminal Menu Structure

The terminal uses function and number keys to navigate through the menu options and to access system settings. Level-1 menus include: Data management, Settings and System Information. Each menu consists of subordinate level-2 menus such as User Registration and View Punches. Level-3 menu include enrollment method selection, sensitivity settings, etc.

Menu structure contains:

- a. **Data Management:** to setup, change or delete data (e.g. enroll fingerprints, passwords, administrators, delete records, track attendance); to perform audits for system changes and set up sensitivity levels for the fingerprint reader.
- b. **Setup:** to set up the TQ100 to communicate with the PC software application.
- c. **System Information:** to examine the information recorded in the terminal and view statistical data.

The structural diagram of the menu is illustrated as follows:

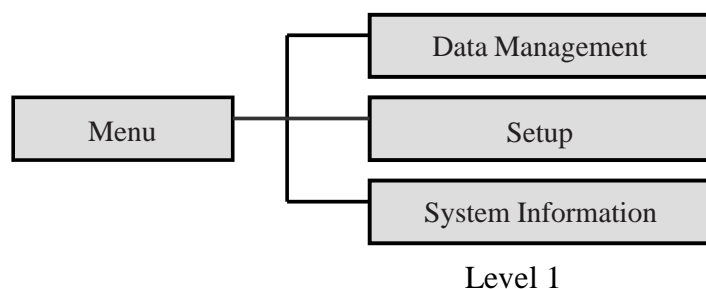

RS485 Connection

For the RS485 communication, TQ100 only uses two wires in the cable, the Brown (8) and the Brown/White (7).

The RS485 communication setup requires the following steps:

1. Take the CAT5 Ethernet cable supplied in the box and cut one end, exposing the wires.
2. Attach an RJ11 connector to the bare end of the cable; looking at the RJ11 connector (see the RS485 wiring diagram below) the Brown wire goes to the leftmost pin. The Brown/White wire goes to the rightmost pin of the RJ11 connector.
3. Connect the cable above one end at the RJ45 Interface of terminal and the RJ11 connector to a Junction Box; the Black wire in the Junction Box should go to the Brown (8) wire in the CAT5 cable, and the Yellow wire in the Junction Box should go to the Brown/White (7) wire.
4. Connect the last Junction Box to a RS485/RS232 converter using a standard phone cable.
5. Connect the RS232 interface to the PC.

RS485 Communication Design

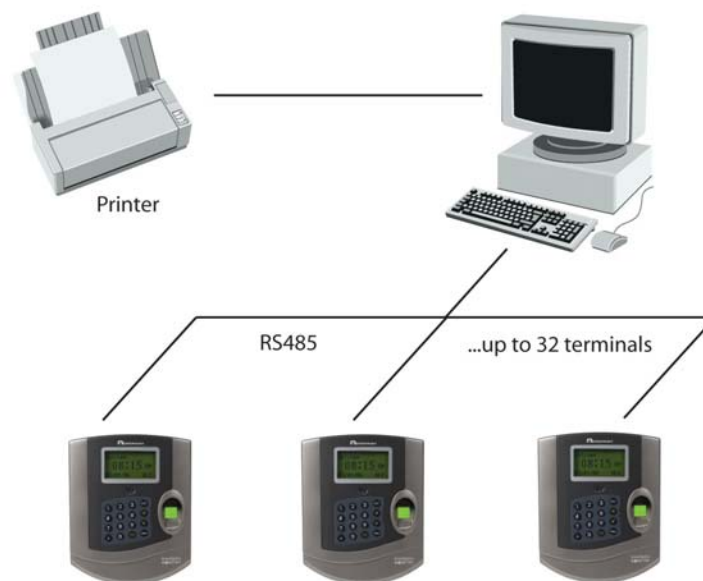

8.2 RJ45 Interface

The RJ45 interface provides RS485 and Ethernet communication.

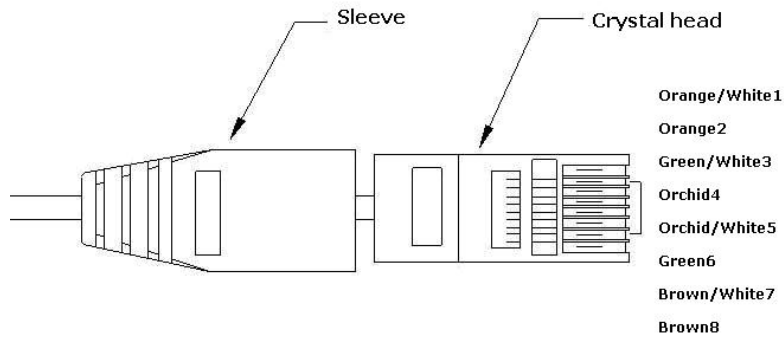

The wiring diagram of the supplied RJ45 connection cable is as follows:

PIN	Definition
1	TCP_TX+
2	TCP_TX-
3	TCP_RX+
4	
5	
6	TCP_RX-
7	RS485A
8	RS485B

3.1 Data Management

With **Data Management** option highlighted, press **OK** to access **Data Management** level-2 menu and browse through the seven items available. Some of the items have corresponding sub-items, the level-3 menu, as shown below:

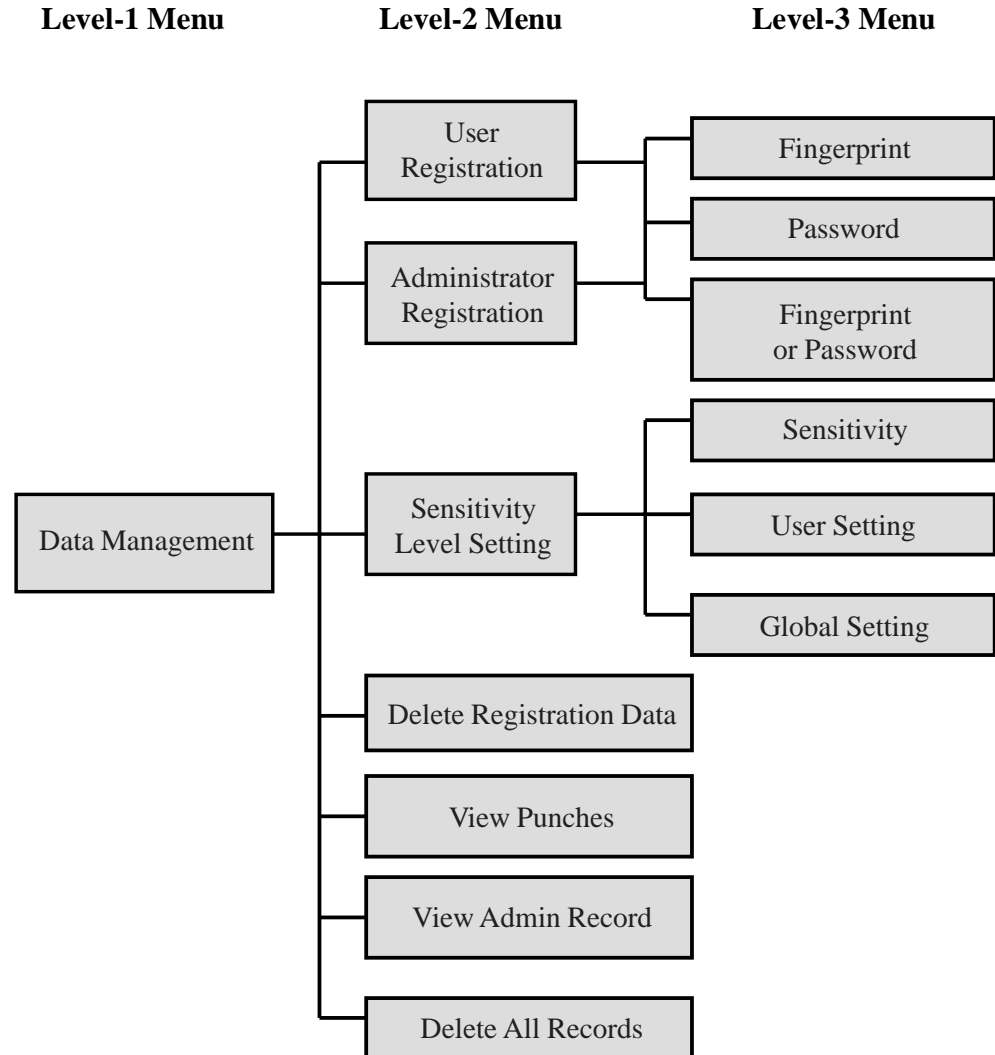

3.2 Setup

With Setup highlighted, press OK to access the Setup level-2 menus and browse the four items available. There are a total of 18 level-3 menus as per the diagram below. For more information on each menu, please refer to page 26.

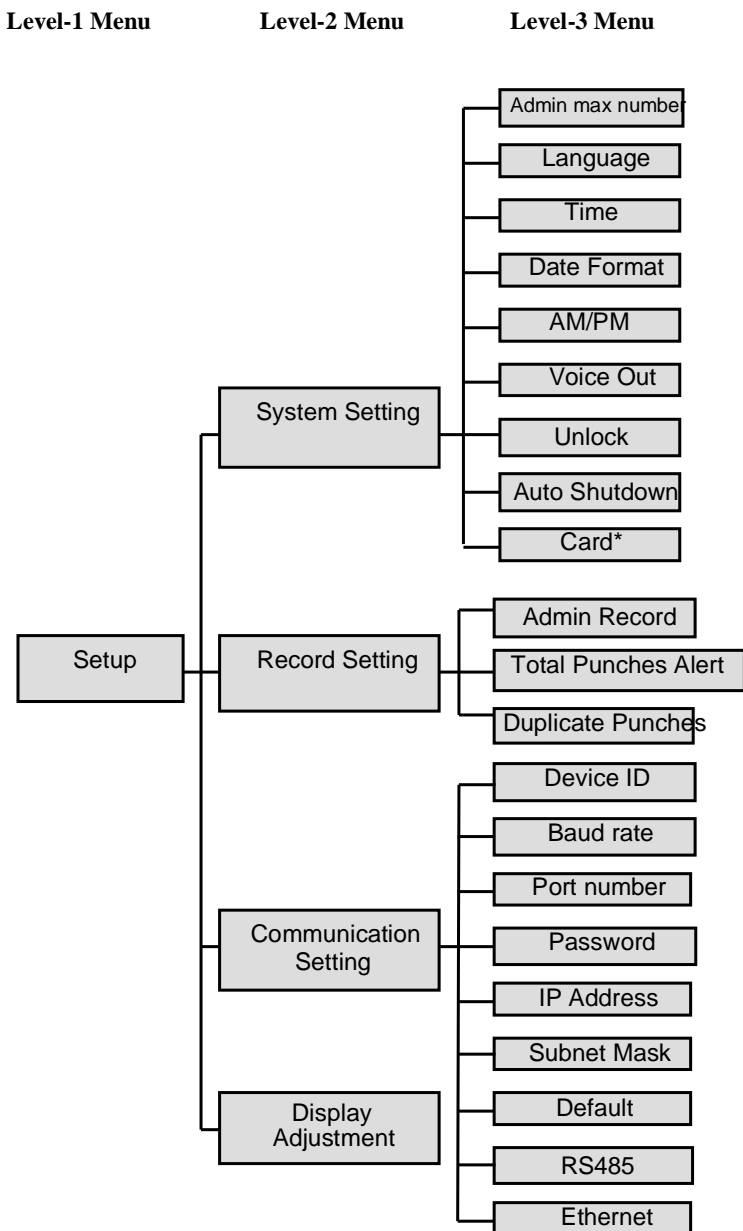

*The card option is not available on standard units.

Chapter Eight: Appendix

Two types of interfaces are available in the terminal: 9-pin RS232 interface (for direct RS232 serial communication) and an RJ45 interface (for RS485 and TCP/IP over Ethernet communications).

8.1 RS232 Interface

The RS232 interface (refer to page 10 figure 4.1) provides RS232 communication, Lock and Wiegand entrance guide function with 9 pins in total. Definitions of each pin are listed in the following table:

PIN	Definition
1	Reserved
2	RS232 TX
3	RS232 RX
4	LOCK Data 1
5	GND
6	Reserved
7	Data ()
8	Reserved
9	Reserved

Note: For door access and/or access control applications: connect with the pins four and five when using the simple entrance guard; white connect pins four five and seven when adopting Wiegand output.

A typical RS232 connections diagram looks like the figure below:

RS232 Communication Diagram

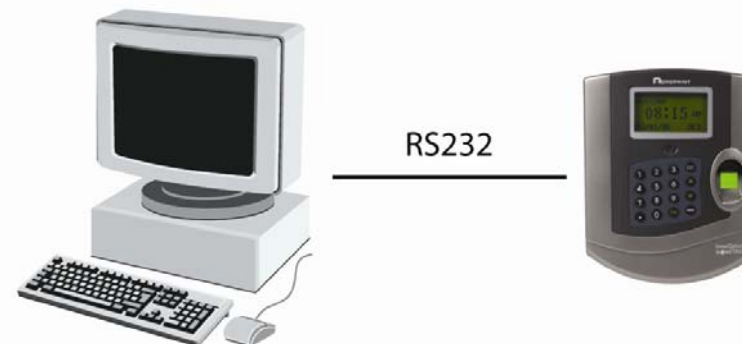

7.2.4 Display Adjustment Setting

Select **Setup** menu and press **OK** to display the following:



Select **Display Adjust** and press **OK**. A “click” sound will be produced indicating that the brightness auto match function of the sampling instrument in the machine is complete. The software will search for the optimal brightness value for the display.

7.3 System Info

Select **System Information** menu and press **OK** to access the level-3 menu as follows:

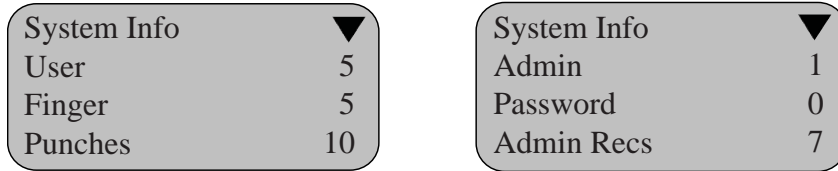

There are 6 level-3 menus in **System Information**, namely User registration, Administrator registration, Fingerprint registration, Password registration, total Punches and Administrator Records. These items can be alternated using the **OK** button.

- 1) **User Registration:** to view the total number of users registered.
- 2) **Administrator Registration:** to view the total number of administrators registered.
- 3) **Fingerprint Registration:** to view the total number of fingerprints registered.
- 4) **Password Registration:** to view the total number of passwords registered.
- 5) **Total Punches:** to view the total number of punches recorded.
- 6) **Administrator records:** to view the total number of admin records.

3.3 System Info

With **System Information** highlighted, press **OK** to access **System Information** level-2 menus. You will see three menu items displayed. Press **OK** in each menu to display the corresponding item as follows:

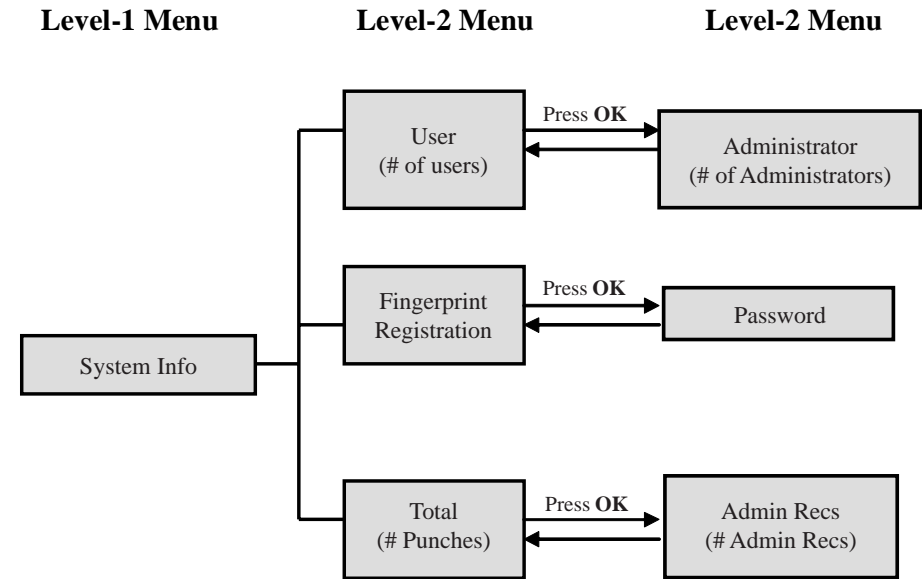

Note: When **User** is selected, pressing **OK** switches between **User** and **Admin**. The other items work in a similar way.

Chapter Four: Communications

4.1 Communication Interfaces

There are two communication interfaces available for the TQ100 terminal: 9-pin RS232 interface and RJ45 interface, as illustrated in the Figure 4.1. The RS232 interface provides RS232 communication, while the RJ45 interface provides RS485 and Ethernet communication, see Figure 4.1 below.

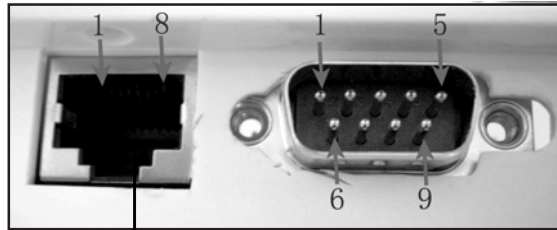

Figure 4.1

RJ45 Interface

RS232 Interface

Attention:

1. Maximum communication distance of RS232 cable is 50 feet (15 m).
2. RS485 communication can connect multiple terminals (up to 32 terminals) and the maximum communication distance can reach 1000 feet (300 m). For optimal performance it is recommended to use up to 10 terminals in a RS485 network installation.
3. Ethernet communication mode belongs to Ethernet network connection. It can be used to connect any terminals in the LAN.

4.2 Communication Options

Choose from three communication options:

1. Direct Connection using RS232 with RS232 communications.
2. RS485 network connection using RJ45 interface
3. Network Connection using Ethernet communication function with RJ45 interface.

7. Default Gateway

Setting Items	Explanation
192.168.1.1	Set the default gateway of the LAN when using the Ethernet communication.
Factory Setting	192.168.1.1

Note: The default gateway must be consistent to the LAN settings.

8. RS485 Communication

Setting Items	Explanation
Yes	Make the RS485 communication available.
Factory Setting	No

9. Ethernet

Setting Items	Explanation
Yes	Make the Ethernet communication available.
Factory Setting	Yes

3. Port Number

Setting Items	Explanation
1 - 9999	To set the software port of the Ethernet communication of the terminal.
Factory Setting	5005

Note: The port number must be consistent to port number of the software in the PC administration machine. No communication can be made otherwise.

4. Password

Setting Items	Explanation
0 - 999999	Set the access password of Ethernet communication
Factory Setting	No

5. IP Address

Setting Items	Explanation
192.168.1.224	Set the IP address of the machine when access through Ethernet communication.
Factory Setting	192.168.1.224

Note: The IP address in the LAN must be unique.

6. Subnet Mask

Setting Items	Explanation
255.255.255.0	Set the subnet mask of the LAN when using Ethernet communication.
Factory Setting	255.255.255.0

Note: Subnet mask must be consistent to the LAN IP address of the device.

4.2.1 Direct Connection using RS232 with RS232 communications

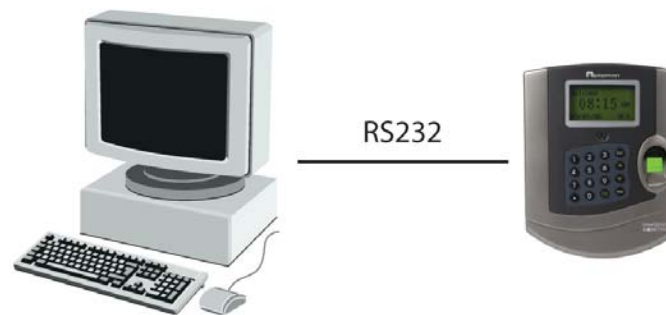

- A) In **Communication** Setting, press **Scroll-down button**. The default display is as follows:

Communication Settings	▼
Device ID	1
Baud Ratio	38400
Port No	80

Note: RS232 is used to directly connect one terminal per computer. In this case, default setting is recommended. For network configurations using multiple terminals, the device ID number must not be repeated and must be set to different numbers.

- B) Turn off the TQ100 terminal.
C) Turn off your PC.
D) Using the thirty foot (9 m) RS232 serial cable included in your package connect one end to your PC communication serial port and the other end to TQ100 terminal.
E) Power on the PC, then the terminal.

4.2.2 RS485 network connection using RJ45 interface

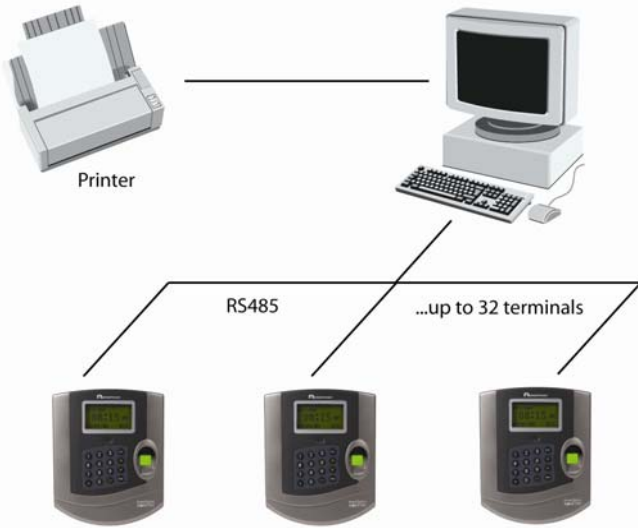

The TQ100 terminal can be connected using RS485. [Please Note: Due to the low demand for this type of connection, the RS232/RS485 converter is not included in the standard package. See the Appendix at the end of this manual for details of the installation and setup of the RS485 configuration].

- A) In **Communication Setting**, press **Scroll-down button** and set **RS485 communication** to “Yes” and **Ethernet** to “No,” displayed as follows:

Communication Setting	▼
Device ID	1
Baud Rate	38400
Port No	80

Note: Device ID number and Baud Rate should be consistent to the PC settings. RS232/RS485 converter is not included in standard configuration.

- B) Turn the terminal off.
 C) Connect the CAT5 Ethernet cable supplied in the package to the RS485/RS232 converter (Please refer to Appendix 8.2 for definition of cables, connectors and wire connections).
 D) Connect RS485/RS232 converter to the serial port of the PC and the other end to the RJ45 interface of the terminal.
 E) Restart the terminal.

7.2.3 Communication Setting

Select **Communication Setting** menu and press OK to access the level-3 menu displayed as follows:

Communication		Communication	
Device ID	1	Password	0
Baud Rate	38400	IP Address	
Port No	5005	Subnet Mask	

Communication Setting	
Subnet mask	1
Default gateway	
RS485 Communication	No
Ethernet	Yes

There are nine level-3 options available for System Setting: Device ID, Baud Rate, Port Number, Password, IP Address, Subnet Mask, Default Gateway, RS485 and Ethernet connections.

1. Device ID (machine number)

Setting Items	Explanation
1 - 255	To set the ID number for machines.
Factory Setting	1

Note: Machine number is the unique ID for each machine. If there are two machines with the same machine number in the network, they will not work properly and the PC software will be confused when polling the terminals. Unique ID numbers need to be allocated for network use.

2. Baud Rate

Setting Items	Explanation
9600	The Baud Rate of Communication Port is set to 9600bps
19200	The Baud Rate of Communication Port is set to 19200bps
38400 (default)	The Baud Rate of Communication Port is set to 38400bps
Factory Setting	38400

Note: The value must be set consistent with the communication ports of the PC Administration Machine. No communication can be achieved otherwise.

2. Total Punches Alert

Setting Items	Explanation
No	Indicates that the terminal will not give out alert when punches stored on the terminal are overflowed. If the total punches surpass the maximum storage capacity, then the terminal will not store any new punches. The maximum storage capacity is 30,000 punches.
1 - 1500	The terminal will inform that the records are overflowed according to the value set. If the value is 1000, then the alert will be given out from the 29,000th record.
Factory Setting	1000

Note: The user is prompted through the message on the display that the punch storage space is reaching maximum capacity. Once the alert is given out, download the records as soon as possible.

3. Punch Interval (duplicate punches)

Setting Items	Explanation
No	Indicates the terminal will record all punches, including duplicate punches.
1 - 255	Indicates the terminal will disregard duplicate punches for subsequent punches received within the period of time that has been set up. The unit of measure is one minute.
Factory Setting	No

Note: If the user punches the terminal repeatedly within the set up interval defined, no duplicate records will be stored.

4.2.3 Network Connection using Ethernet communication function with RJ45 interface

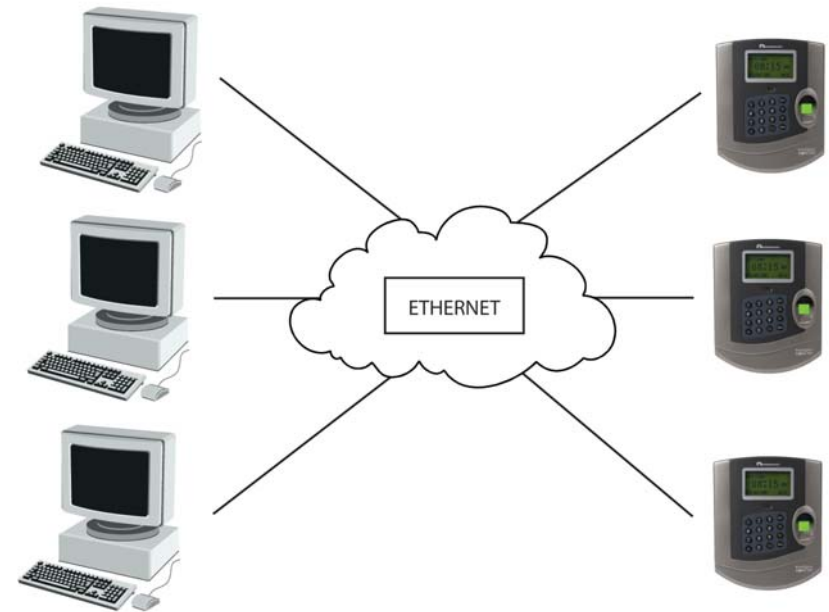

- A) In **Communication Setting**, press **Scroll-down** to set **RS485** communication to "No" and set **Ethernet** to "Yes", displayed as follows:

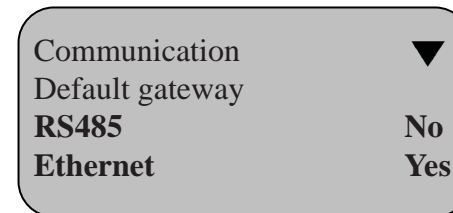

Note: A 6 ft Ethernet cable is included in the standard package.

- B) Set the IP address, subnet mask and default gateway to those of the LAN. The IP address must be unique. The same password must be used both in the terminal setup and PC software.
- C) Turn the terminal off.
- D) Connect the network cable of the LAN to the RJ45 interface of the terminal.
- E) Turn on the terminal.

Chapter Five: Fingerprint Registration/Enrollment

When the TQ100 terminal and AttendanceRx software installation is complete, fingerprints will first be enrolled and then validated.

For a network installation with multiple terminals a user's enrollment is only needed on one terminal. Any timeQplus administrator can enable the enrolled user to use any terminal in the network.

5.1 Enrollment Method

Correct enrollment method:

- One or multiple fingerprints can be enrolled for every employee.
- It is recommended to use the index finger and/or middle finger for enrollment.
- Position your finger in the middle of the sensor. Apply light pressure.

Tips for improving the quality of fingerprint read:

Dirty or Dry Finger	Clean your finger with a moisturized soap; Wipe your finger with a pre- moisturized tissue (alcohol-free wipes, preferably enriched to hydrate the skin)
How to choose your finger	Use the index or middle finger to enroll; try left hand fingers if the right hand (index or middle finger) fingerprints are faded, worn or missing.
Incorrect positioning	Place your finger in the middle on the sensor; keep you finger flat on the sensor and apply pressure trying to cover as much of the sensor window as possible; DO NOT touch the sensor in an angled or tilted position, DO NOT slide your finger.
Fingerprint image changes	Re-enroll your finger if your fingerprint changes as a result of an injury, etc.
Fingerprint difficult to read	Use one (1:1) identification method. Key in your PIN number and place your finger on the sensor.
Other reasons	Use password registration as backup for people with hard to read fingerprints.

5. Unlock*

Setup Value	Explanation
Yes/No	Set the door lock option
Factory Setting	No

**Note: this function is not supported in the AttendanceRx software.*

6. Auto Off

Setup Value	Explanation
1-255	Set the Auto shutdown option
Factory Setting	No

7.2.2 Record Setting

Select **Record Setting** menu, press **OK** to enter the level-3 menu as follows:

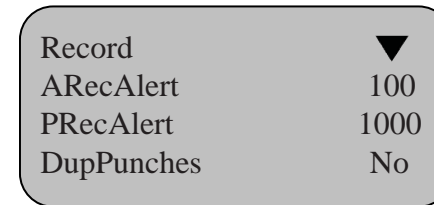

There are three level-3 menus in Record Setting: Administrator Record Alert, Total Punches Record Alert and Punch Interval setting, defaulted as per below:

1. Admin Record Alert

Setting Items	Explanation
No	The terminal will not give out an alert when the admin records have overflowed. If the admin records surpass the maximum storage capacity, then the terminal will not store any new admin records. The maximum storage capacity for administrator records is 1000.
1 - 255	The terminal will give out alert according to the value set to inform the overflow of management records. If the value is 100, then the alert will be given out from the 900th record.
Factory Setting	100

Note: The user is prompted through the message on the display that the management record space is reaching the maximum capacity.

There are a total of six level-3 menus in the System Setting: Total Number of Administrators, Language, Time Setting, Voice Out, Unlock and Auto Shutdown, defaulted as below:

1. Total Number of Administrators

Setup Value	Explanation
1-10	Set the total number of the administrators for the terminal
Factory Setting	5

2. Language

Setup Value	Explanation
ENG	Content of the interface is displayed in English
Factory Setting	English

3. Time Setting

Setup Value	Explanation
Time	Time setting for the terminal.
Factory Setting	Time setting of the terminal is consistent to the settings of the PC. It can also be set up using the PC software.

4. Voice Out

Setup Value	Explanation
Yes/No	Set the voice out option
Factory Setting	Yes

The correct finger positioning method is illustrated below, front and side view.

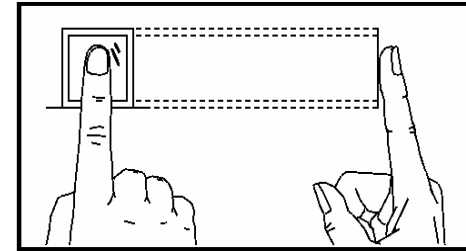

Correct

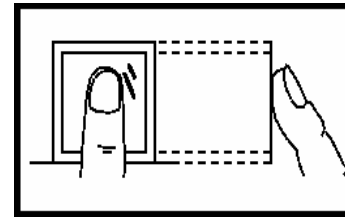

Not flat

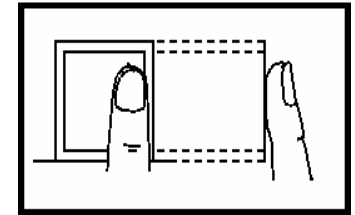

Off center

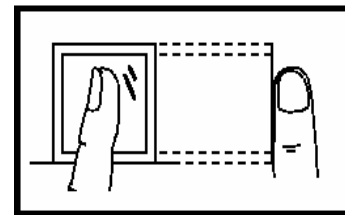

Tilted

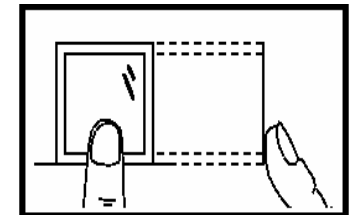

Too Low

5.2 Fingerprint Registration

There are two registration modes available for the terminal: fingerprint and password.

A unique ID number per user is required for enrollment. For each ID number you can enroll up to 10 fingerprints and 1 password. When the terminal is powered up, the interface looks similar to below:

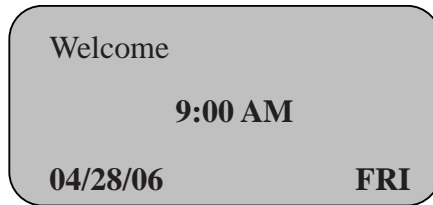

With the terminal powered on, please follow the detailed instructions below to enroll an employee's fingerprint:

Select the **Menu** option; once that is displayed you will see the following image, and then select **Data Management**.

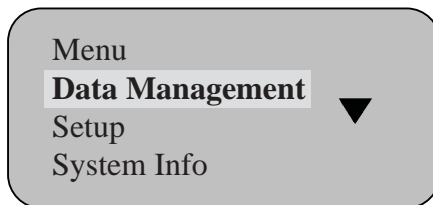

Press **OK** to display the following:

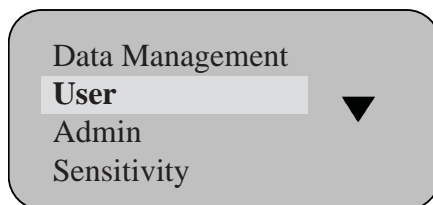

7.1.8 Display Messaging

1. When viewing punches, the initials displayed on the interface have the following meanings:
 - V_F: The registration type is fingerprint
 - V_P: The registration type is password
2. When viewing admin records, the initials on the interface have the following meanings:
 - E_U: General User Registration
 - E_M: Administrator Registration
 - E_DF: Delete Fingerprint Registration Record
 - E_DP: Delete Password Registration Record
 - D_L: Delete All Record Data
 - S_T: Time Setting
 - S_S: System Setting
 - S_L: Record Setting
 - S_C: Communication Setting

7.2 Setup

Press **MENU** to enter and select Setup menu. Then press **OK** to access the level-2 menu with the following display:

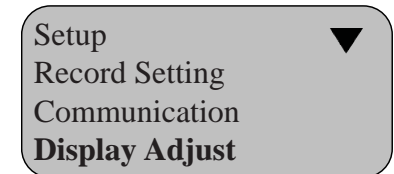
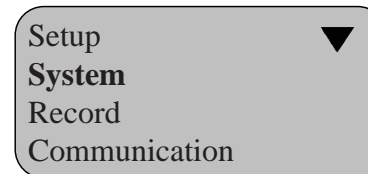

The Setup menu consists of System Setting, Record Setting, Communication Setting and Display Adjustment Setting.

7.2.1 System Setting

In **System Setting**, press **OK** to display the following:

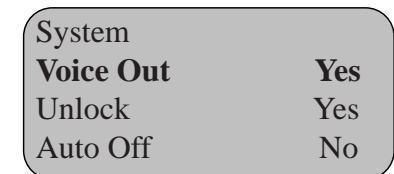
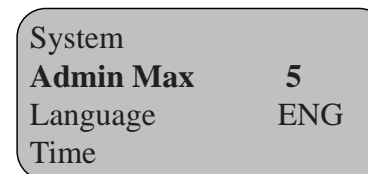

7.1.6 Select **View Admin Records** menu and press **OK** to access the level-3 menu as follows:

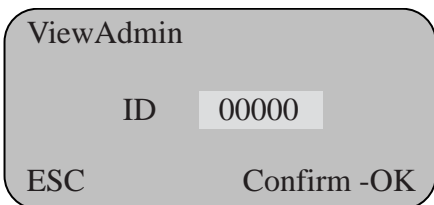

After entering the administrator user ID number, press **OK** to display the following:

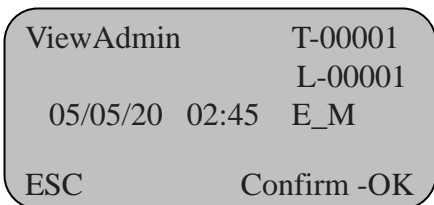

Note: T-00001: Total number of admin events is 1
 L-00001: The last recorded admin event
 05/05/20 20:45: Admin/setup time
 E_M: indicates type of admin operation performed (see 7.1.8 below)

The interface displays the total occurrences when the administrator has managed/setup the machine, the detailed time of each occurrence, and type of operation performed.

7.1.7 Select **Delete All Records** menu and press **OK** to access the level-3 menu as follows:

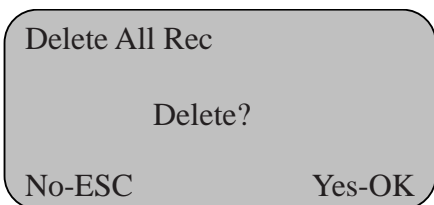

Note: When the command "Delete all records" is confirmed, all the records stored on the terminal will be deleted.

Press **OK** to delete all records, press **ESC** to cancel and exit.

Press **OK** to display the following:

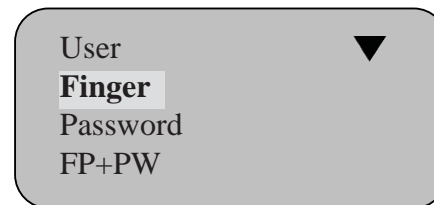

Press **OK** to display the following:

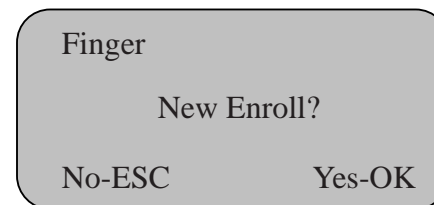
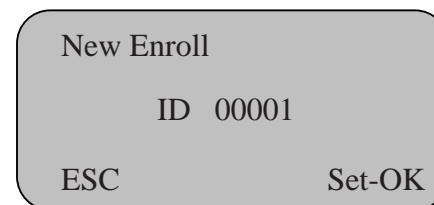

Figure A

Press **OK** to display the following:



Note: ID range can be any combination of numbers from 00001 - 65535

In the process of enrolling employee's passwords, when the user ID is introduced, the zero digits located at the beginning of the number sequence are not required to key in. Example: If the user ID number is "0050", the user needs to key in only "50".

Accept the user ID displayed or key in a user ID and press **OK** to display the following:

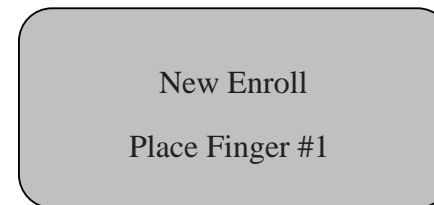

Press finger on the sensor window and remove it following the instructions on the screen. Press the same finger a second time and third time according to the instructions displayed.

If the registration fails, the screen displays the message below and the previous step needs to be repeated.

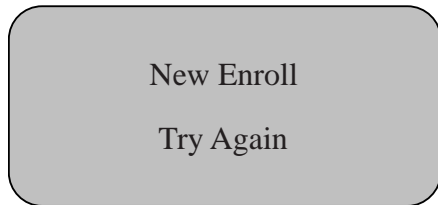

If the registration is successful, the following message is displayed:

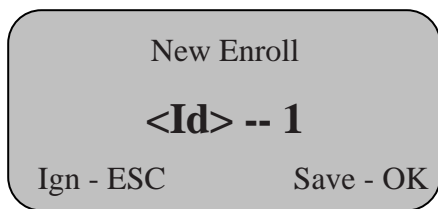

Note: 00001 - 1
 The digit following the hyphen (-) represents the first fingerprint for this employee. You can enroll up to 10 fingerprints per employee.

Press **OK** to save and go to the screen below; press **ESC** to redo the fingerprint enrollment (Fig A).

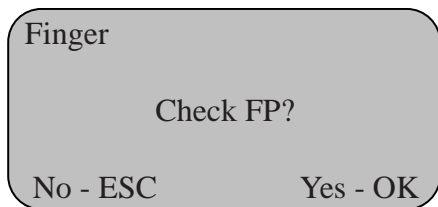

Press **OK** to check registration per below; press **ESC** to continue enrolling fingerprints (Fig A).

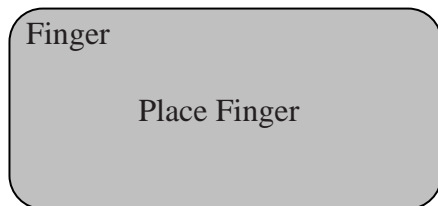

7.1.5 Select **ViewPunch** option in the menu and press **OK** to access the level-3 menu as follows:

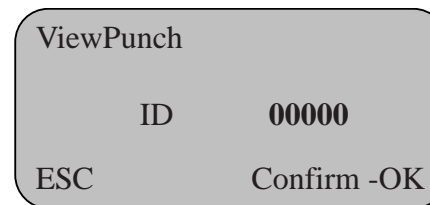

Input the ID number to be viewed (e.g. 0001) and then press **OK** to display the following:

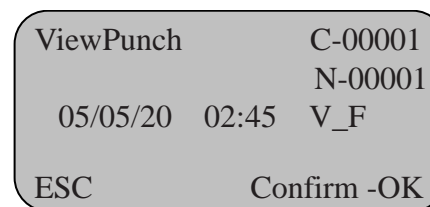

Note: C-00001: total number of punches is 1
 N-00001: indicates the latest record
 05/05/20 02:45: validation time
 V_F: indicates registration type is fingerprint

The interface displays the total number of punches validated with fingerprint, the detailed time of each occurrence (punch), user registration number and type of each validation.

7.1.4 Select **Delete Registration Data** menu and press **OK** to access the level-3 menu as follows:

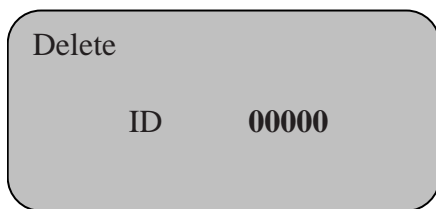

Input the User ID to be deleted, e.g. number 00001, and then press **OK** to display the following:

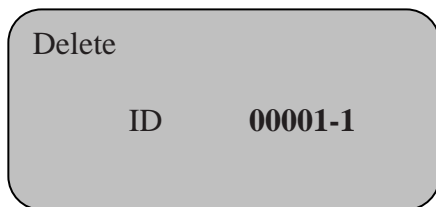

Note: the last digit indicates the first fingerprint.

Press **OK** to confirm:

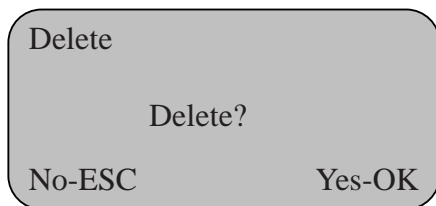

Press **OK** to delete. A "click" sound will be sent out with a prompt of "Enroll Empty." Then it will return to the delete user interface as below; press **ESC** to cancel and exit.

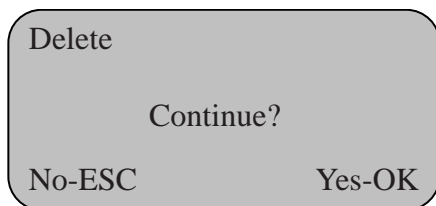

It is recommended to perform a fingerprint check to confirm its validity. If it validates, it means that your enrolled fingerprint is of good quality and the message in Figure B below is displayed. If the fingerprint fails, the enrolled fingerprint is not clear and validation errors are likely to occur in the future, see Figure C; in this case enrollment should be redone and/or a different finger used.

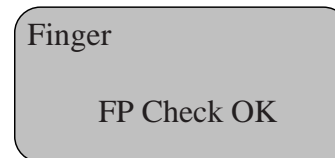

Figure B

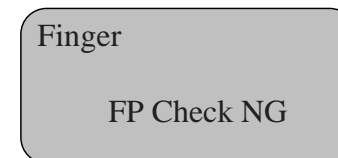
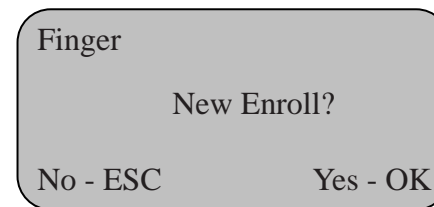

Figure C

Next the screen is displayed and a new enrollment cycle begins as shown below.



Press **OK** to continue enrolling new users; press **ESC** to enroll backup (multiple) fingerprints for a user (Fig D)

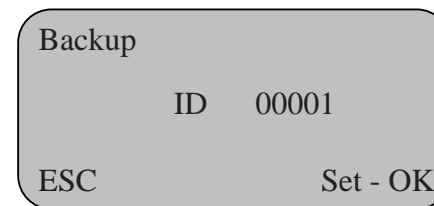

Figure D

If you want to enroll fingerprint backups for existing users, enter the user ID number of the employee you want to add fingerprint backups for. For password registration, an explanation will be given in "**Chapter Seven: Administrator Functions**," 7.1.1 and 7.1.2.

Chapter Six: Terminal Usage and Punching In/Out

6.1 Successful validation when punching In/Out

For every successful punch, the message on the interface displays as below, and if activated, a voice prompt saying "Thank you" is heard.

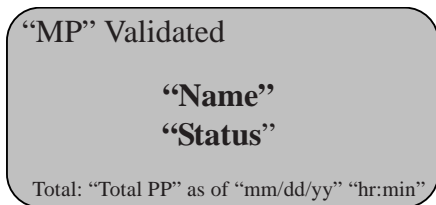

- A) "MP" = method of punch; FP = fingerprint; PW = password
- B) "Name" = employee last name and initial of first name
- C) "Status" = IN /OUT
- D) "Total PP" = total number of hours worked in the current pay period as of the last update cycle
- E) "mm/dd/yy" and "hr:min" = date and time of the last update cycle, see "Total PP" above

Example:

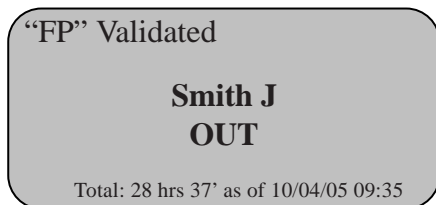

Attention:

1. When the user punches the terminal, make sure that the fingerprint used to punch has been previously enrolled and the finger is properly pressed on the reader, see page 15.
2. For the terminals set with the Duplicate Punch Interval option enabled, if the user punches the terminal multiple times during the time interval that has been set up, the interface of the terminal will display "Double Punch" and a long beep is heard; Attention: only the first successful punch recorded within that window frame will be saved.

7.1.2 Select **Administrator Registration** menu by pressing Admin and press OK to access the level-3 menu as follows:

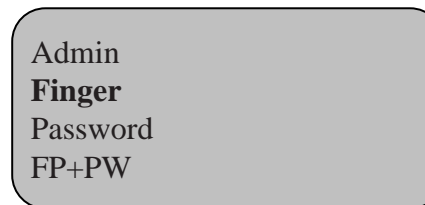

Refer to **Chapter Five** for fingerprint enrollment and 7.1.1 for password registration.

7.1.3 Select **Sensitivity Level Setting** menu and press **OK** to access the level-3 menu as follows:

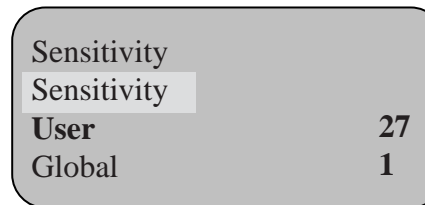

Note:

- User setting value range = 0-50; the default value is 27.
- Global setting value range = 1-4; the default value is 1.

The Sensitivity Level Setting is a balanced value of FAR (False Accept Rate) and FRR (False Reject Rate). FAR indicates that the machine accepts the fingerprint of user A as the identity of user B; while FRR means that the machine rejects a fingerprint that has been enrolled. Global setting value is based on the sensitivity level value of all the users while User setting value is based on the sensitivity level value of each individual.

In general use, Global setting value based on all users can be set (default value is 1). For individuals who are difficult to pass validation, the password registration method can be used.

If the fingerprint of a certain user is faint or hard to read, the User setting value can be reduced to improve the validation pass rate by selecting the highlighted option above and changing the default value.

Press **OK** or enter the corresponding ID number of the person and press **OK** to display the following:

A terminal screen with a light gray background and rounded corners. At the top, the word "Password" is displayed. Below it, "PW In" is followed by a black rectangular redaction box. At the bottom left, "ESC" is displayed, and at the bottom right, "Set-OK" is displayed.

Enter password and then press **OK** to display the following:

A terminal screen with a light gray background and rounded corners. At the top, the word "Password" is displayed. Below it, "PW In" is followed by four asterisks "****". At the bottom left, "Confirm" is displayed, and at the bottom right, "Save-OK" is displayed.

Note: 4 digits is the maximum length for password.

After the password is confirmed, press **OK** to display the following:

A terminal screen with a light gray background and rounded corners. At the top, the word "Password" is displayed. Below it, "User ID-P" is displayed. At the bottom left, "Ign-ESC" is displayed, and at the bottom right, "Save-OK" is displayed.

Note: User ID-P
Letter P means that the registration type is password.

Press **OK** to save. If the registration is successful, the following screen prompts the user for next enrollment.

A terminal screen with a light gray background and rounded corners. At the top, the word "Password" is displayed. Below it, "ID" is followed by "00003". At the bottom left, "ESC" is displayed, and at the bottom right, "Set-OK" is displayed.

Press **OK** to continue enrolling new passwords for other User ID numbers, press **ESC** to exit.

6.2 Unsuccessful validation when punching In/Out

A. When fingerprint validation method is used:

If the fingerprint validation fails, the user will hear a vocal message saying "Please try again".

The message displayed will show:

A terminal screen with a light gray background and rounded corners. The text "FP Check Failed" is displayed at the top, and "Try again!" is displayed below it.

Refer to **Chapter Five** to ensure that the correct fingerprint method is used.

B. When the password validation is used:

If the password validation fails, the user will hear a vocal message saying "Please try again", the following message is displayed:

A terminal screen with a light gray background and rounded corners. The text "PW Check" is displayed at the top, and "Enter again" is displayed below it.

Chapter Seven: Administrator Functions

Attention:

If there are no administrators enrolled, administrator settings can be accessed and modified by any user. The administrators must be enrolled and validated. Before any set up changes are performed, the administrator must be enrolled and validated. Then the administrator can perform administrative as well as time and attendance functions. The users without administrative rights can only use the time and attendance function.

At the terminal, administrators can perform setup changes, enroll and delete users, and visualize records, but the punches can only be edited at the PC using AttendanceRx software.

Press **MENU** to display the menu structure; if no administrator is enrolled the following will be displayed:

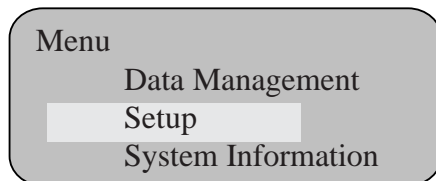

Administrators can be enrolled following the steps detailed in 7.1.2. When one or more administrators are enrolled on the terminal, the following message is displayed:

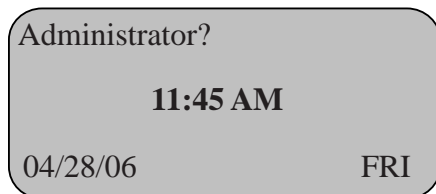

When administrator validation fails (incorrect fingerprint or password), the message "Invalid" or "Not Found" is displayed. The administrator validation process should be restarted. If successful, the administrator is able to access the menu interface.

To log in as Administrator:

1. For administrators enrolled with fingerprint, press **MENU** first and then press the finger you want to validate on the sensor window. Upon successful validation, the menu interface is displayed.
2. For administrators enrolled with passwords, press **MENU** first, then key in the User ID Number, press **OK**, and then key in the password followed by **OK**. If validated, the menu interface will be displayed.

If the terminal can not be accessed because the Admin information is missing (like unknown fingerprint or password), please take the following steps to unlock the terminal: power off the terminal, keep the "Esc" key pressed, power on the terminal, read the baud rate and terminal ID info from the screen that is displayed. To revert to normal operation press any other key on the keypad. Then you need to connect the terminal to the software running on your PC via RS232 connection, add the terminal and remove all data to clear the Admin information.

7.1 Data Management

Press the **Scroll-down** button to browse the menu structure.

Select **Data Management** and press **OK** to enter the level-2 menu interface as follows:

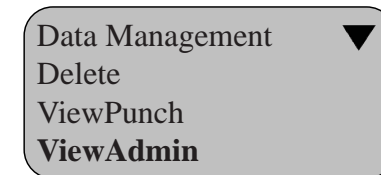
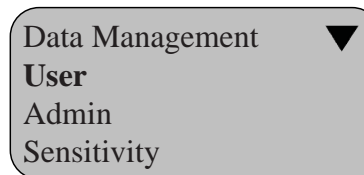

There are a total of seven level-2 menus in Data Management, namely User registration, Administrator registration, Sensitivity level setting, Delete registration data, View punches, View admin record, and Delete all records.

7.1.1 Select **User** registration menu and then press **OK** to enter the level-3 menu as follows:

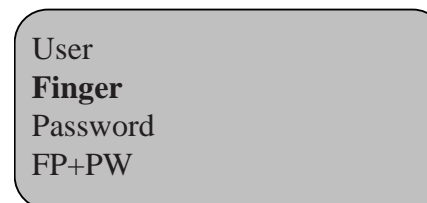

Select fingerprint registration and then press **OK**; refer to Chapter Five for fingerprint enrollment.

Select password registration and press **OK** to display the following:

